





ASSEMBLY INSTRUCTIONS

MODEL: PL152SGD-A3

2DR SET

Before assembly, please remove all parts from the carton, verifying that you have the correct quantities, and read all the instructions.

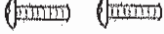
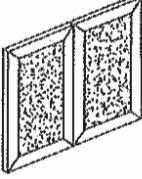
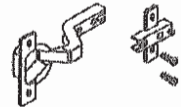
IN THE CARTON:

1  Glass Pads 4Pcs	2  Self-Drilling screws 8 Pcs	3  Handle Screws 4 Pcs	A  Aluminium Glass Door Set	*4  Softclosing Door Hinges 2 Pairs included in cabinet box	*5  Wood screws 8Pcs
--	--	--	--	--	--

INSTRUCTIONS:

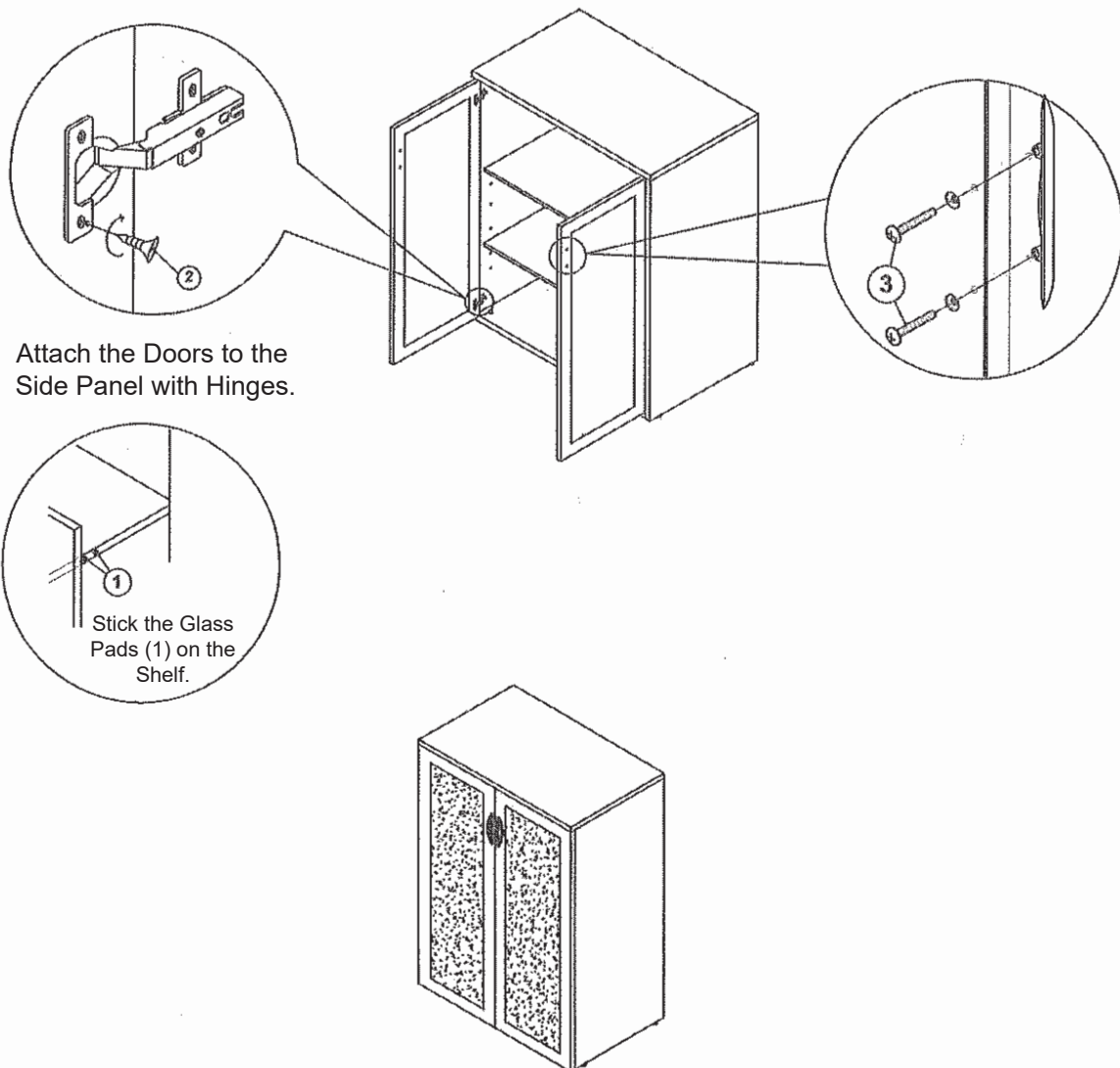

Attach the Doors to the Side Panel with Hinges.

Stick the Glass Pads (1) on the Shelf.

⚠ ATTENTION ⚠

Place all wooden parts on a clean and smooth surface such as a rug or carpet to avoid the parts from being scratched. Check that you have all parts and hardware. Remove all wrapping materials, including staples & packing straps before you start to assemble. Do not tighten any screws or bolts until the unit is completely assembled. Keep all hardware parts out of reach of children. There may be extra hardware when install is complete.