







**MODEL: PLTRB2319BRU, PLTRB2328BRU  
ROUND BRUSHED ALUMINUM PEDESTAL BASE**

**TABLE BASE PARTS LIST**

	M8*40 mm Bolts **Pre-installed on post	5 pcs
	Locking Washers	5 pcs
	Allen Key	1 pc
	Wood Screw M4*25	8 pcs
	Top Plate	1 pc
	Center Post	1 pc
	Table Base	1 pc

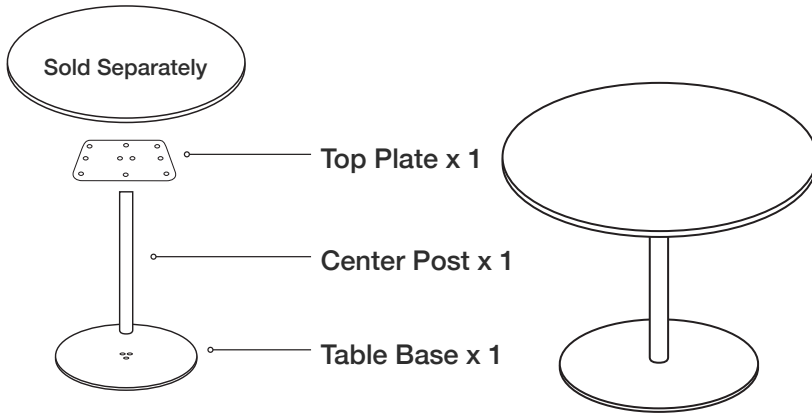

1. Remove factory installed bolts from top and bottom of posts.

2. Attach base to center post using 3 bolts and 3 Locking washer with allen key

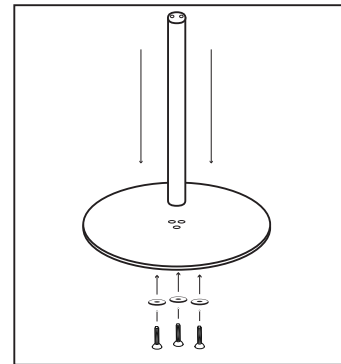
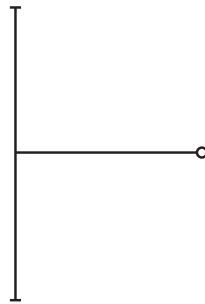

3. Attach top plate to center post using 2 bolts 2 Locking washer with allen key

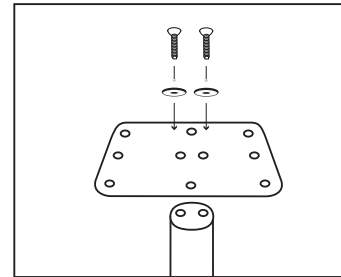
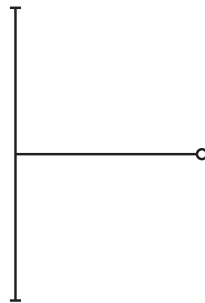

4. Attach top plate to wood top using 8 wood screws.

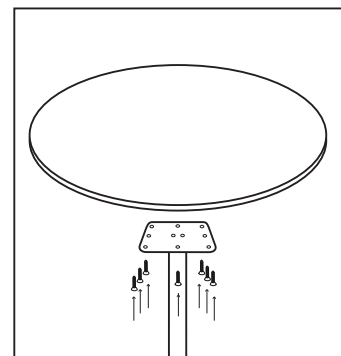
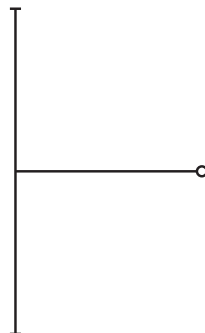

\*PLTRB2341 to be used with 36" or smaller tops